

ALUMINUM TRUCK DOCKPLATE - EH-4848

APPROX WEIGHT: 126.89 lbs.
 DOES NOT INCLUDE WEIGHT OF POWER OR PACKAGING!!!

*** ANY ADDITIONS, DELETIONS, OR OMISSIONS MUST BE CORRECTED ON THIS DRAWING AS THIS DRAWING WILL BE CONSIDERED ALL INCLUSIVE ***

ALL GRAPHICS PROVIDED ARE FOR REFERENCE ONLY. IF CERTAIN DIMENSIONS ARE CRITICAL PLEASE VERIFY THOSE DIMENSIONS WITH YOUR SALESPERSON

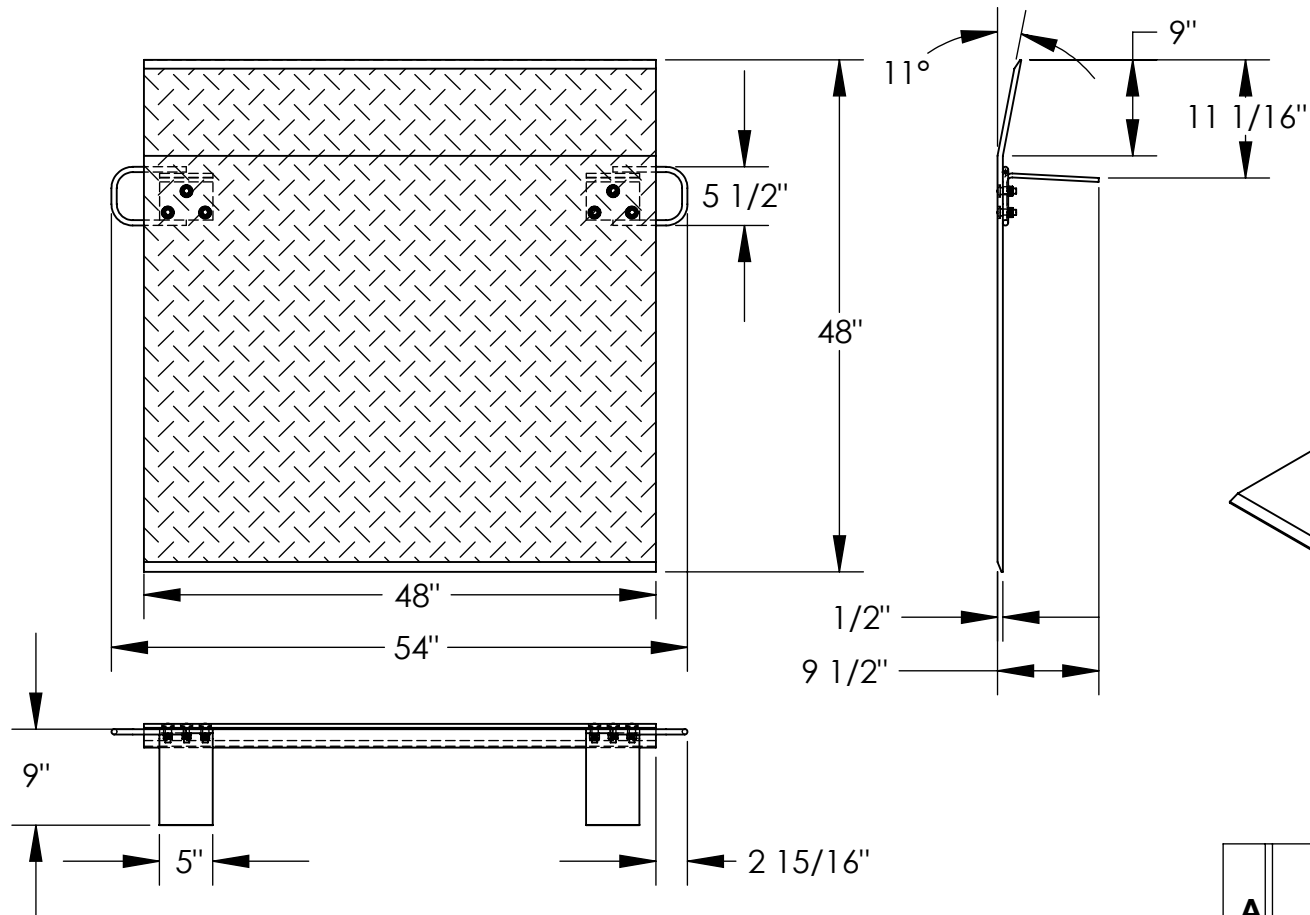

NOTE: BEND OR CROWN IS 11° AND LOCATED 9" FROM EDGE OF DOCKPLATE

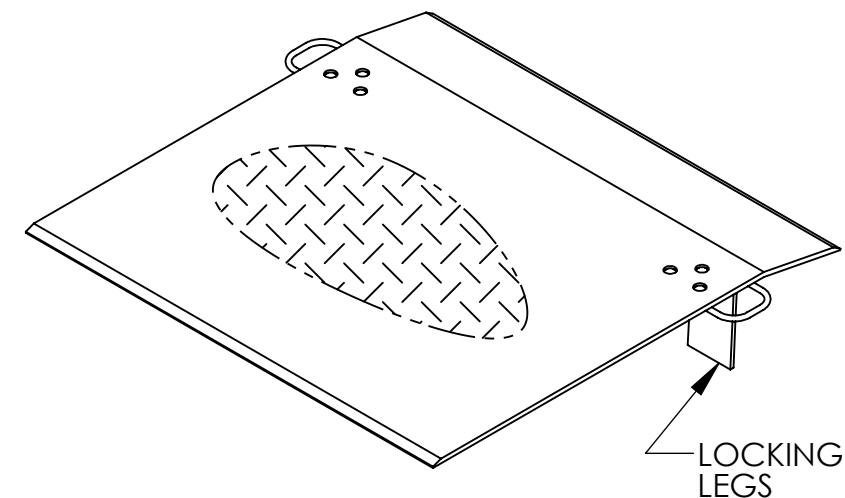

SCALE 1:16
 DIMENSION TOLERANCE ± 1/4"

STANDARD FEATURES

- MODEL NUMBER IS EH-4848
- CAPACITY IS 3,800 LBS.
- OVERALL WIDTH IS 54"
- DECK WIDTH IS 48"
- OVERALL LENGTH IS 48"
- OVERALL HEIGHT IS 9 1/2"
- THICKNESS IS 1/2"
- HANDLES ARE 5 1/2" x 2 15/16"
- LOCKING LEGS ARE 5" x 9"

SPECIAL FEATURES

NONE

APPROVAL

I, THE UNDERSIGNED, AGREE THAT THE PRODUCT AS REPRESENTED SATISFIES DESIGN AND DIMENSION REQUIREMENTS. I ALSO ACKNOWLEDGE MY DUTY TO CONFIRM PRODUCT AND INSTALLATION COMPLIANCE WITH ALL APPLICABLE FEDERAL, STATE AND LOCAL REGULATIONS AND STANDARDS.
UNITS REQUIRING APPROVAL DRAWINGS OR MODIFIED ARE NON-RETURNABLE
 As drawn As marked

Signed: _____ Date: _____

Printed Name: _____

LEAD TIME WILL START UPON RECEIPT OF SIGNED APPROVAL DRAWING

DISTRIBUTOR'S NAME:		P.O.#
VESTIL MANUFACTURING		X
DRAWN BY: ADL		W.O.#
DATE: 1/19/06		X
REFERENCE: X	SCALE: 1:18	SALES: X
QUOTED LEAD TIME: X	QUOTE #	FILE NAME:
	X	12-007-032